

CEME a Win-Win Partner

ITALIAN PUMPS FOR COFFEE WORLDWIDE



ULKA

COFFEE DIVISION

GENERAL CATALOGUE

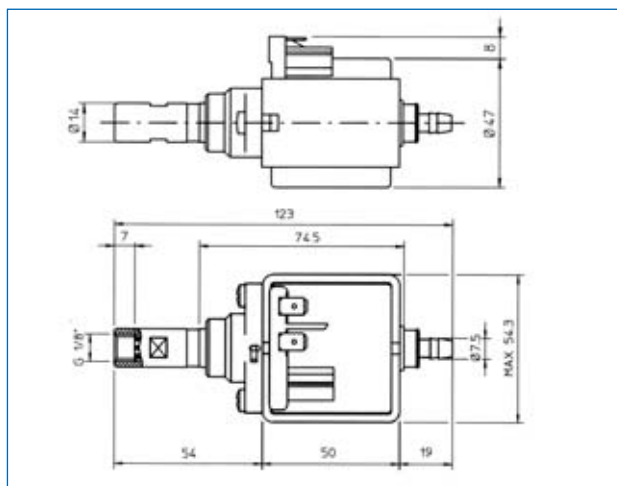

EP USCITA IN PLASTICA
PLASTIC OUTLET

EX USCITA IN OTTONE
BRASS OUTLET

Models	E4	E4R	E5	E5D	EK	EK2	E7	E77	E8	E8S	E8R	E8LT
Average Pressure (Bar)	20	9	15	15	16	15,5	7	4	2,5	2,5	2,2	2
Average Flow Rate (cc/min)	450	350	650	300	700	650	1000	900	1200	1200	650	1100
Noise [dB(A)] at p=0 Bar/20cm	58	60	64,5	60	67,2	67,2	67,8	65,8	60	73	58	55,5

POMPA EVOLUZIONE	EVOLUTION PUMP
Corrente alternata	Alternating current
Fluido ideale: acqua	Ideal fluid:water
Autoinnescante a pressione 0	Self-priming at 0 bar
Non idonea all'utilizzo a secco tranne che per i normali interventi di innesco	Suitable to dry-use only during priming
Diode integrato	Integrated diode
Faston 6.3 x 0,8	Electrical connections: 6.3 x 0,8
Raccordo uscita snodato	A joint making the pump independent from the hydraulic connection at the delivery is provided
Tasca per termoprotettore	Thermal cutout pocket
Produzione e collaudo automatizzati e computerizzati	Computer-based production and inspection
Test elettrici e idraulici al 100%	Full detailed electrical and hydraulic inspection

Prestazione a bobina fredda	Cold coil performances
V=Vn	V=Vn
Temperatura ambiente 25°C	Room temperature at 25°C
Fluido: acqua a 20°C	Fluid: water at 20°C

Models		E4 - Voltage	E5 - ON/OFF (min)	E7 - Class	W	Certificates
EP4, EP5, EP7, EP5 D	EX4, EX5, EX7, EX5 D	240V~50Hz	2/1	F	48	IMQ
		230V~50Hz	2/1	F	48	IMQ/VDE
		220V~50Hz	2/1	F	48	IMQ
EAP4, EAP5, EAP7, EAP5 D	EAX4, EAX5, EAX7, EAX5 D	220V~60Hz	1/2	A	64	c-UL
EP4, EP5, EP7, EP5 D	EX4, EX5, EX7, EX5D	200V~50-60Hz	2/1	F	48	-
		120V~60Hz	1/1	A	41	c-UL
EAP4, EAP5, EAP7, EAP5 D	EAX4, EAX5, EAX7, EAX5 D	120V~60Hz	1/1,5	A	52	c-UL
EFP4, EFP5, EFP7, EFP5 D	EFX4, EFX5, EFX7, EFX5 D	120V~60Hz	2/1	F	52	c-UL
EP4, EP5, EP7, EP5 D	EX4, EX5, EX7, EP5 D	100V~50-60Hz	2/1	F	55	-
		24V~50-60Hz	2/1	F	48	-

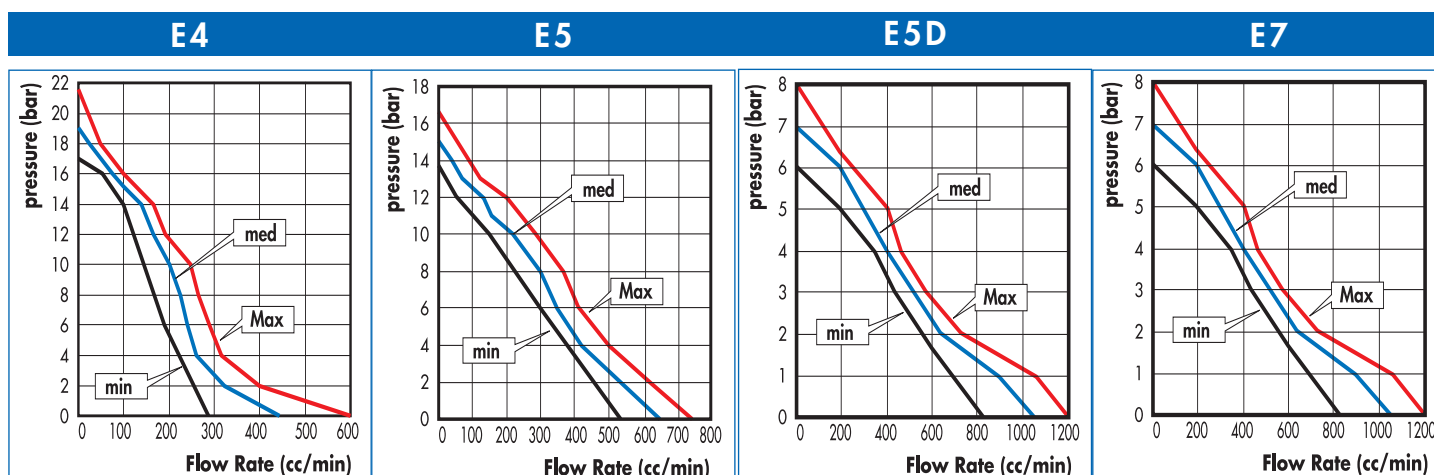

Models		E4FM - Voltage	E5FM - ON/OFF (min)	Class	W	Certificates
EP4FM-EP5FM		230V~50Hz	2/1	F	40	VDE
EP4FM-EP5FM		120V~60Hz	2/1	F	46	c-UL

Temporary - Values to be set up - Tolerancy +/- 15%

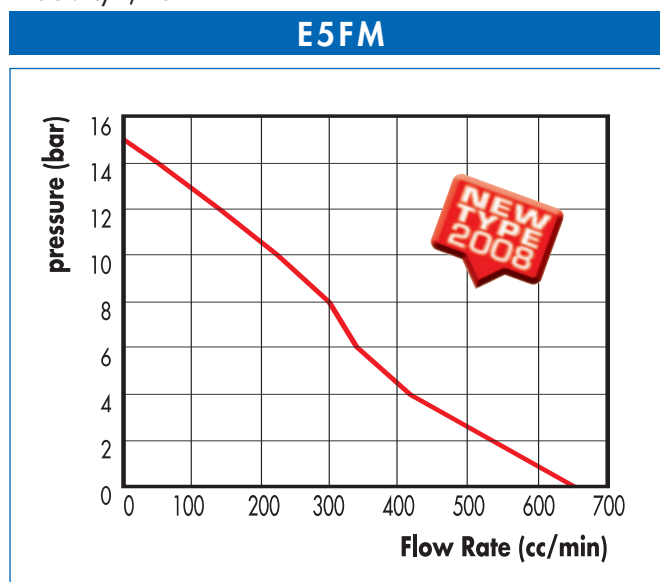
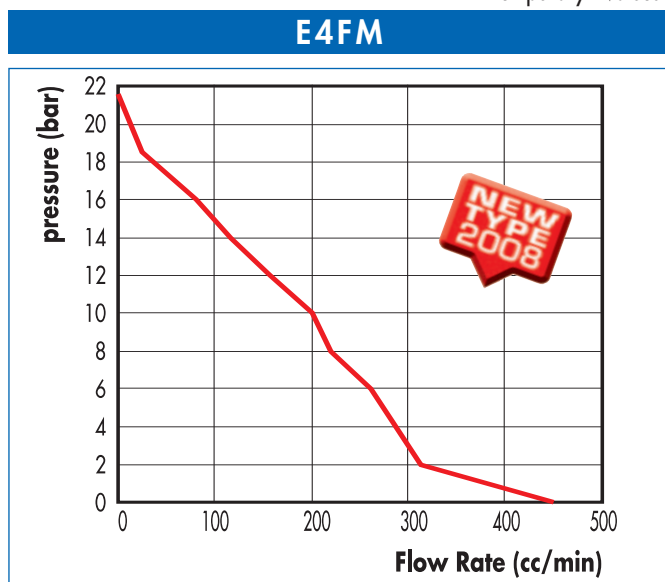

EK		EK2			
Models	Voltage	ON/OFF (min)	Class	W	Certificates
EK	220V~50Hz	1/1	F	54	IMQ
EK2	230V~50Hz	1/1	F	56	IMQ/VDE

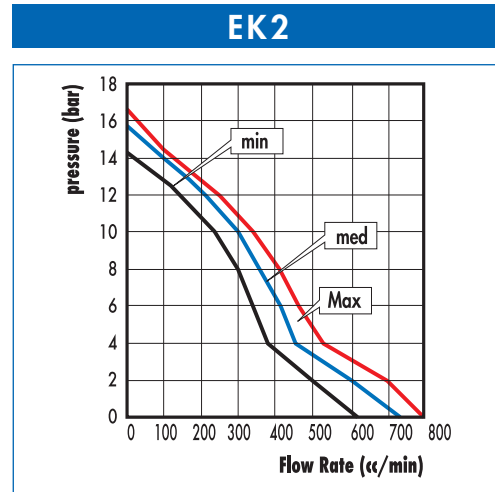
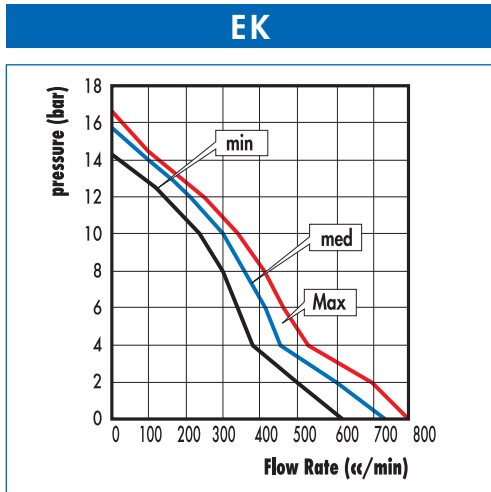

ER						
Models		Voltage	ON/OFF (min)	Class	W	Certificates
EP4R, EP8R	EX4R, EX8R	230V~50Hz	1/1	F	42	VDE
		120V~60Hz	1/1	F	46	c-UL
		100V~50-60Hz	1/1	F	46	-

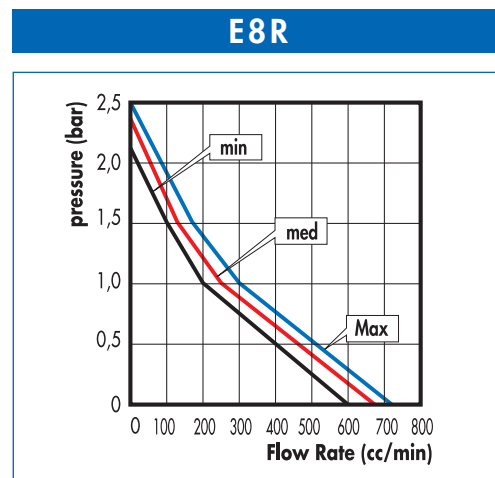
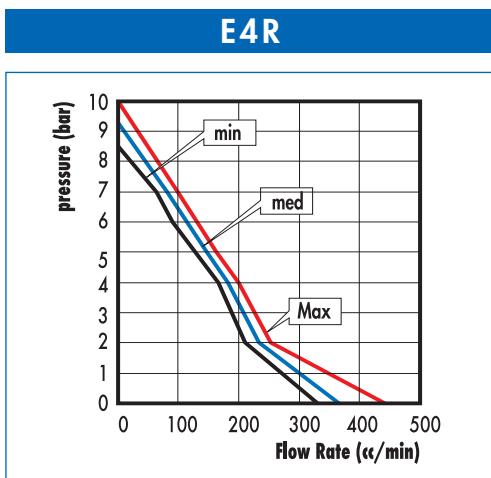

Prestazione a bobina fredda	Cold coil performances
V=Vn	V=Vn
Temperatura ambiente 25°C	Room temperature at 25°C
Fluido: acqua a 20°C	Fluid: water at 20°C

E77

Models	Voltage	ON/OFF (min)	Class	W	Certificates	
EP77	EX77	230V~50Hz	100%	F	28	VDE
		220V~50-60Hz	100%	F	35	-
		120V~60Hz	100%	A	27	UL
		100V~50-60Hz	100%	F	31	-

E77

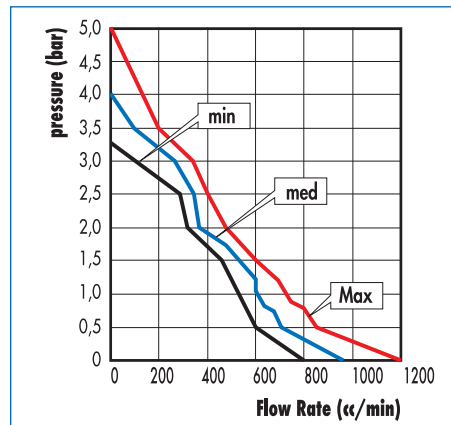

E8 - E8S

Models	Voltage	ON/OFF (min)	Class	W	Certificates	
EP8, EP8S	EX8, EX8S	230V-240V~50Hz	100%	F	26	VDE
		220V~50-60Hz	100%	F	33	-
		120V~60Hz	100%	F	29	c-UL
		100V~50-60Hz	100%	F	28	-
		24V~50Hz	100%	F	28	-

E8 - E8S

Per funzionamento continuo.
E8S anche a secco fino a 30 minuti.
Suitable for continuous working.
E8S even up-to-30-minute dry-working.

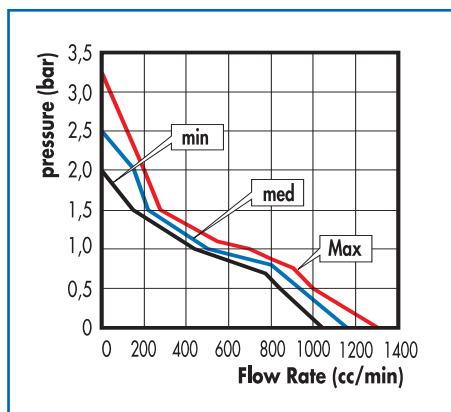

Prestazione a bobina fredda	Cold coil performances
V=Vn	V=Vn
Temperatura ambiente 25°C	Room temperature at 25°C
Fluido: acqua a 20°C	Fluid: water at 20°C

E8LT

Models	Voltage	ON/OFF (min)	Class	W	Certificates	
EP8LT	EX8LT	230-240V~50Hz	100%	F	20	VDE
		120V~60Hz	100%	F	23	c-UI

E8LT

Per funzionamento continuo senza termostato, anche a secco!

Suitable for continuous working without thermal protection, even dry!

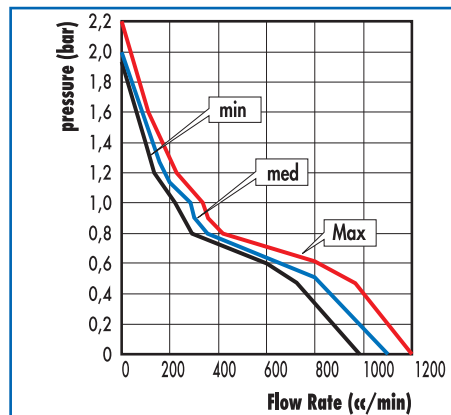
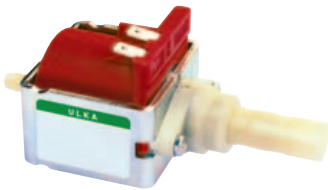

SCHEMA DI PROVA - TEST PROCEDURE

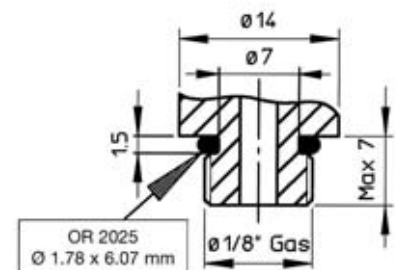
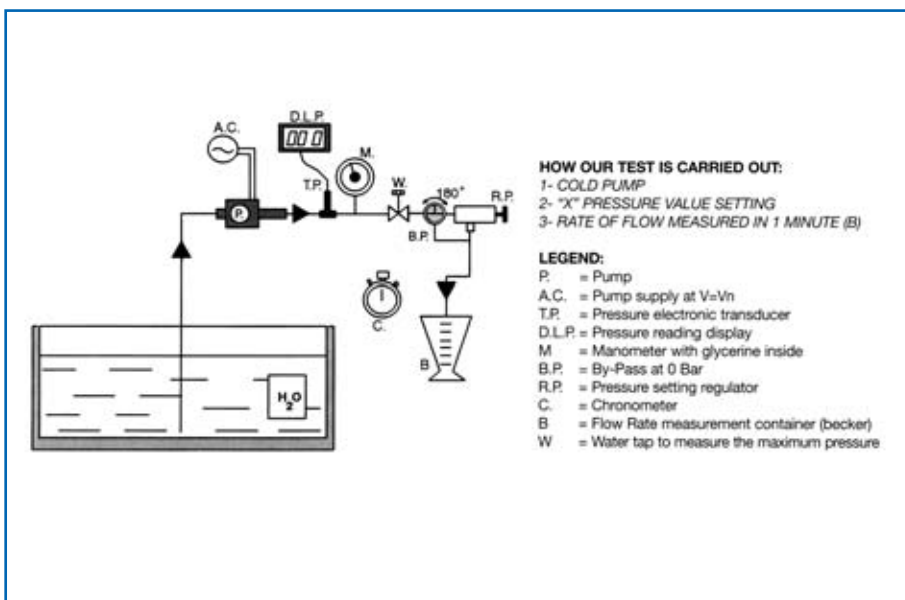

Schema di connessione e tenuta idraulica ideale da applicare alla mandata delle pompe E

Drawing showing the ideal junction and hydraulic seal to be applied at the delivery of the pump type E



Ø A	Description
6.6	Standard
5.0	R5
M10x1	RF

IN COMPLIANCE WITH THE 2002/95/CE ROHS DIRECTIVE

Class F					Integrated Diode 1 N 4007 1000V Without Diode, description: ND							
Voltage available and Relative Certification					TYPES	NME 1	NME 1C	NME 1S	NME 2	NME 3	NME 4	NME 5 (*)
Voltage	Hz	ON/OFF (min)	W	Certificates	Average Flow-rate (cc/min)	200	220	180	110	90	50	20-30
230-240	50	100%	16	VDE	Max pressure (Bar)	2,5	2,0	3,2	2,5	2,5	2,5	1
220	60	100%	16	-	dB(A) at p=0 Bar/20cm	50	44	51	40	39	36	-
120	60	100%	16	c-UR								
100	50-60	100%	16	-								
24	50-60	100%	16	-								



(*) Temporary - Values to be set up - Tolerancy +/- 15%

NME1

Cold Performance:

V=Vn - Water 20°C - Ambient temperature 25°C

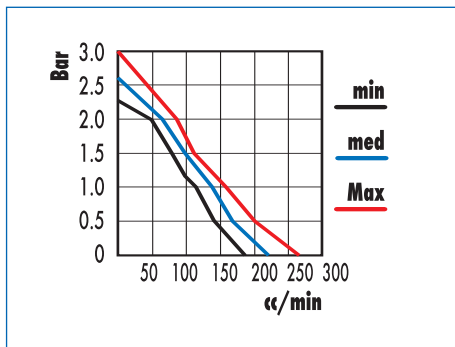

Flow rate/Time:

V=Vn - Water 20°C - Ambient temperature 25°C

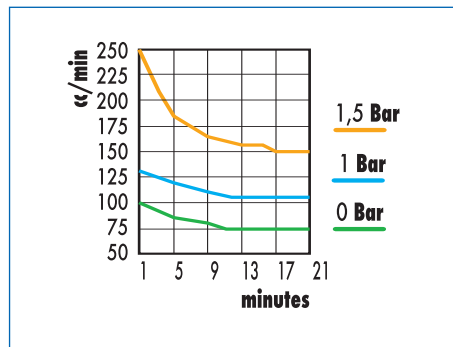

Heating test:

Water 20°C - Ambient temp. 25°C V=Vn+6%-p=0 Bar

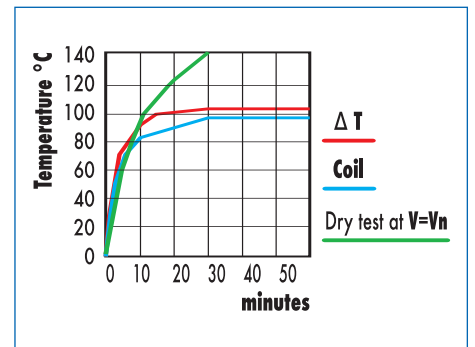

NME1C

Cold Performance:

V=Vn - Water 20°C - Ambient temperature 25°C

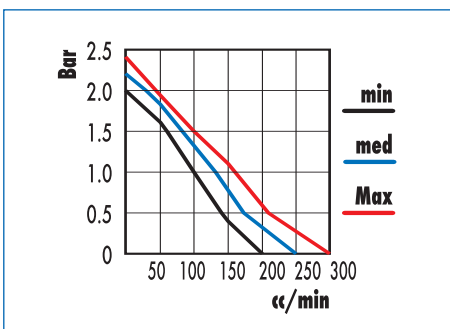

Flow rate/Time:

V=Vn - Water 20°C - Ambient temperature 25°C

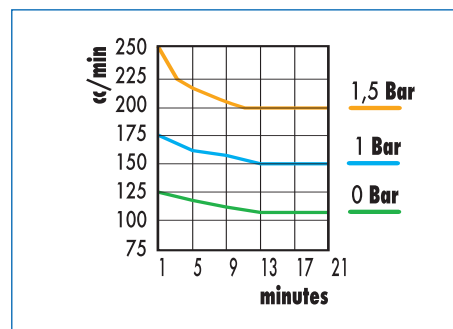

Heating test:

Water 20°C - Ambient temp. 25°C V=Vn+6%-p=0 Bar

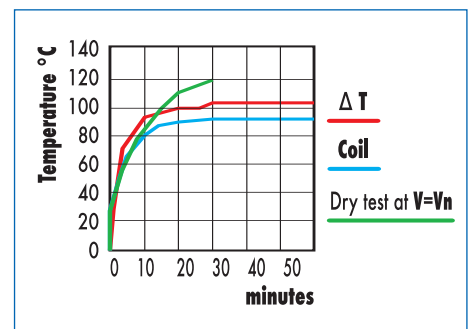

NME1S

Cold Performance:

V=Vn - Water 20°C - Ambient temperature 25°C

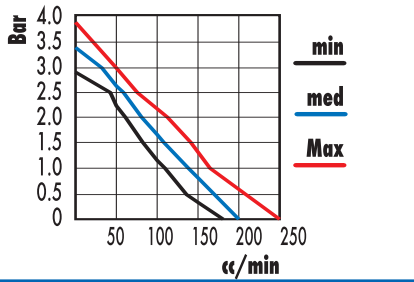

Flow rate/Time:

V=Vn - Water 20°C - Ambient temperature 25°C

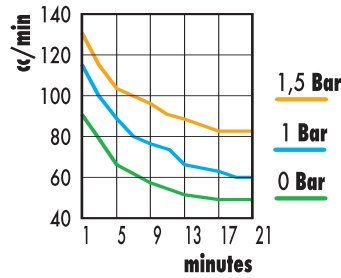

Heating test:

Water 20°C - Ambient temp. 25°C V=Vn+6%-p=0 Bar

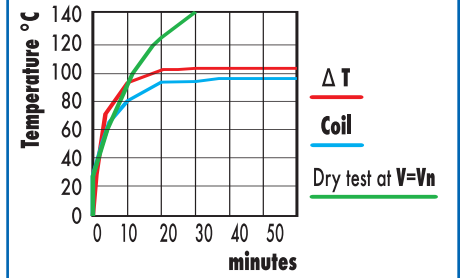

NME2

Cold Performance:

V=Vn - Water 20°C - Ambient temperature 25°C

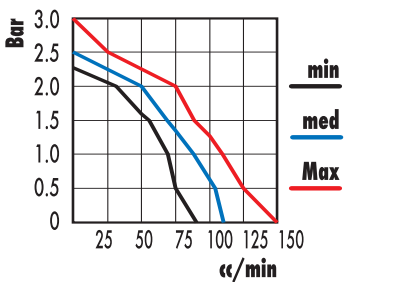

Flow rate/Time:

V=Vn - Water 20°C - Ambient temperature 25°C

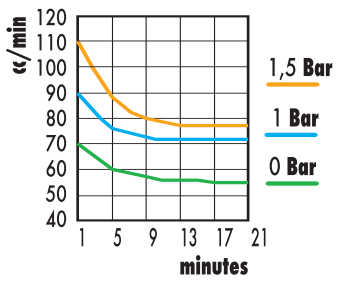

Heating test:

Water 20°C - Ambient temp. 25°C V=Vn+6%-p=0 Bar

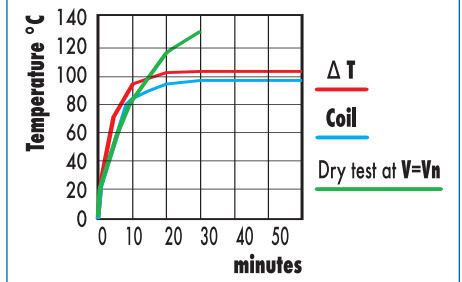

NME3

Cold Performance:

V=Vn - Water 20°C - Ambient temperature 25°C

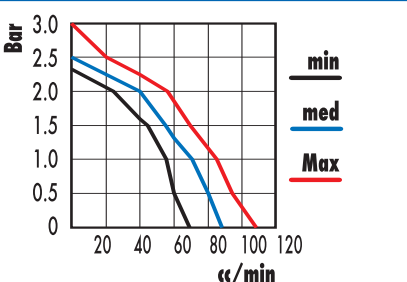

Flow rate/Time:

V=Vn - Water 20°C - Ambient temperature 25°C

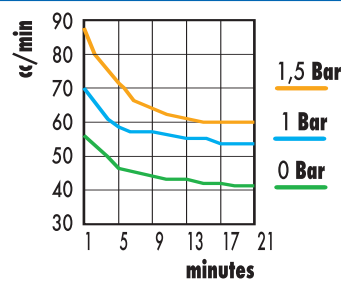

Heating test:

Water 20°C - Ambient temp. 25°C V=Vn+6%-p=0 Bar

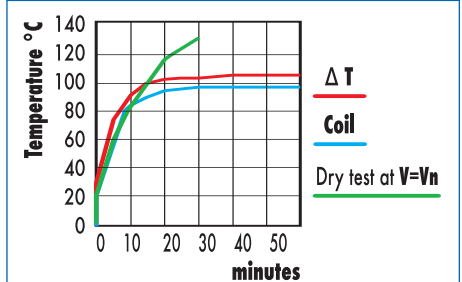

NME3S

Cold Performance:

V=Vn - Water 20°C - Ambient temperature 25°C

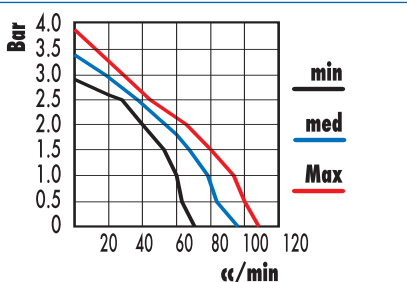

Flow rate/Time:

V=Vn - Water 20°C - Ambient temperature 25°C

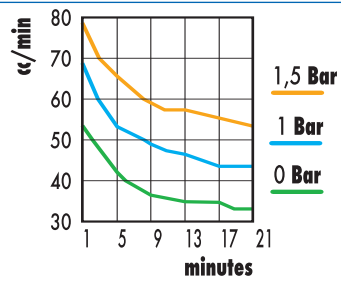

Heating test:

Water 20°C - Ambient temp. 25°C V=Vn+6%-p=0 Bar

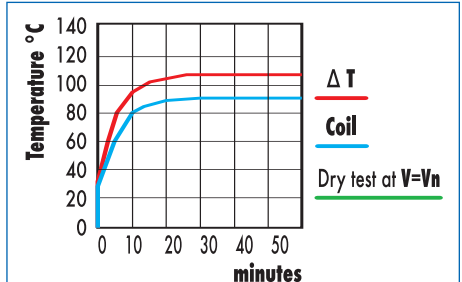

NME4

Cold Performance:

V=Vn - Water 20°C - Ambient temperature 25°C

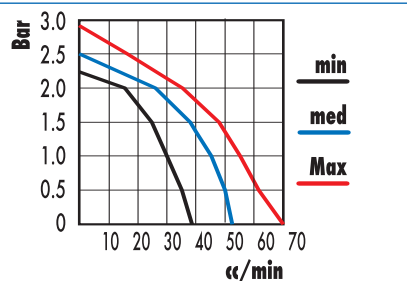

Flow rate/Time:

V=Vn - Water 20°C - Ambient temperature 25°C

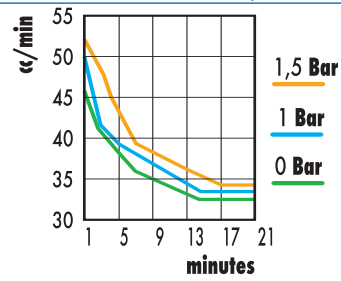

Heating test:

Water 20°C - Ambient temp. 25°C V=Vn+6%-p=0 Bar

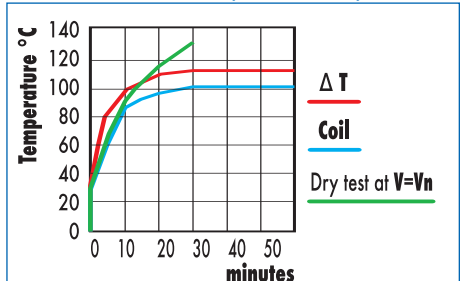

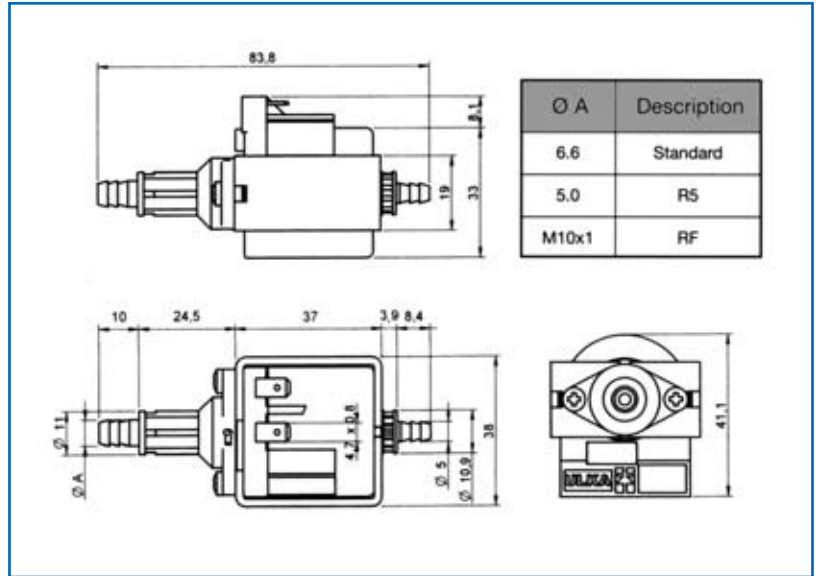

CERTIFIED

IN COMPLIANCE WITH
THE 2002/95/CE
ROSH DIRECTIVE

Class F	Integrated Diode 1 N 4007 1000V Without Diode, description: ND				
	Voltage	Hz	ON/OFF (min)	W	Certificates
Voltage available and Relative Certification	230-240	50	100%	21	VDE
	120	60	100%	17	c-UR
	220	60	100%	21	-
	100	50-60	100%	21	-
	24	50-60	100%	17	-

Tolerancy +/- 15%

NMEHP1

Cold Performance:
V=Vn - Water 20°C - Ambient temperature 25°C

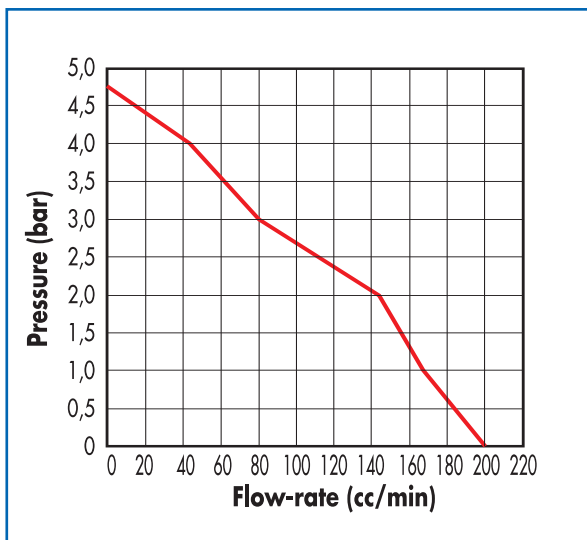

NMEHP2

Cold Performance:
V=Vn - Water 20°C - Ambient temperature 25°C

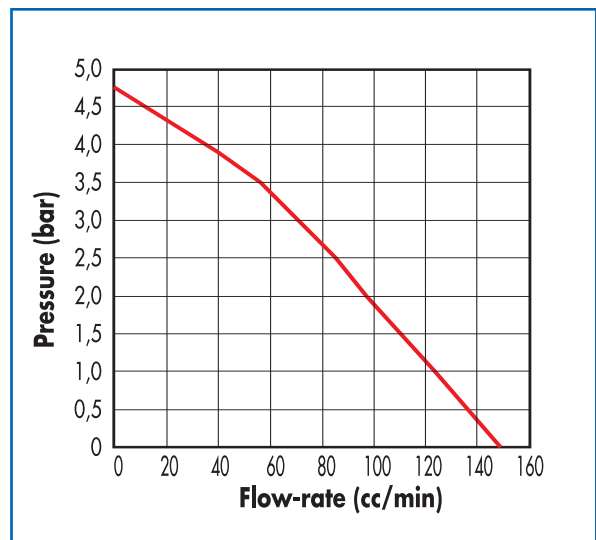

NMEHP3

Cold Performance:

V=Vn - Water 20°C - Ambient temperature 25°C

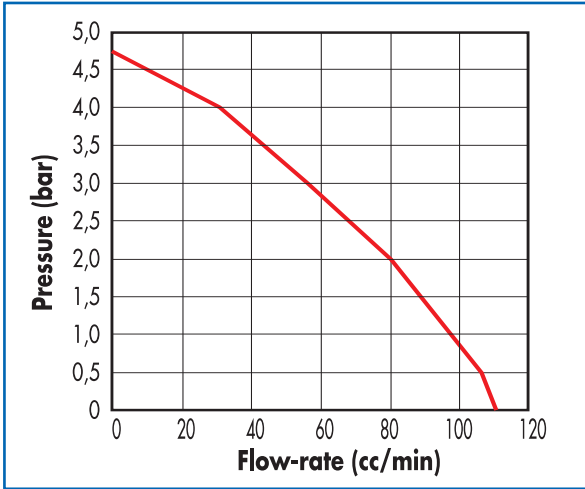

NMEHP4

Cold Performance:

V=Vn - Water 20°C - Ambient temperature 25°C

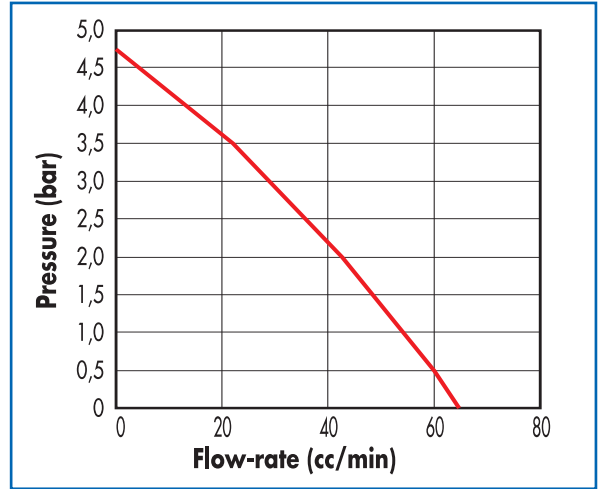

Heating test: Water 20°C - Ambient temperature 25°C V=Vn+6°C-p=0 Bar

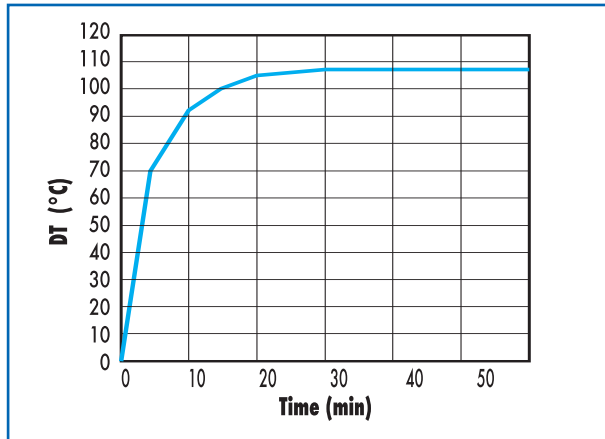

NMEHP1S

Cold Performance: V=Vn - Water 20°C - Ambient temperature 25°C

Class F	Integrated Diode 1 N 4007 1000V Without Diode, description: ND				
	Voltage	Hz	ON/OFF (min)	W	Certificates
Voltage available and Relative Certification	230-240	50	1/1	16	VDE

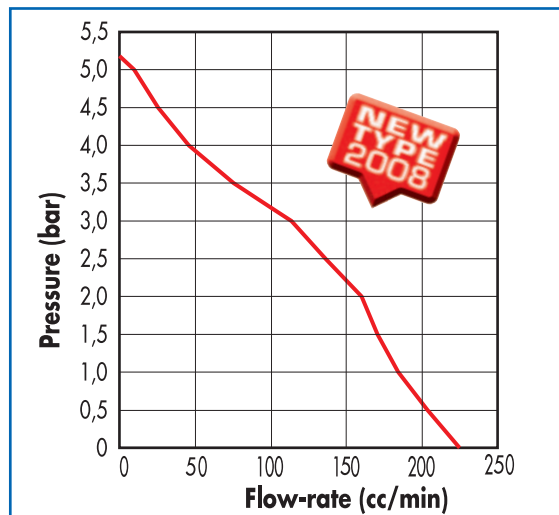

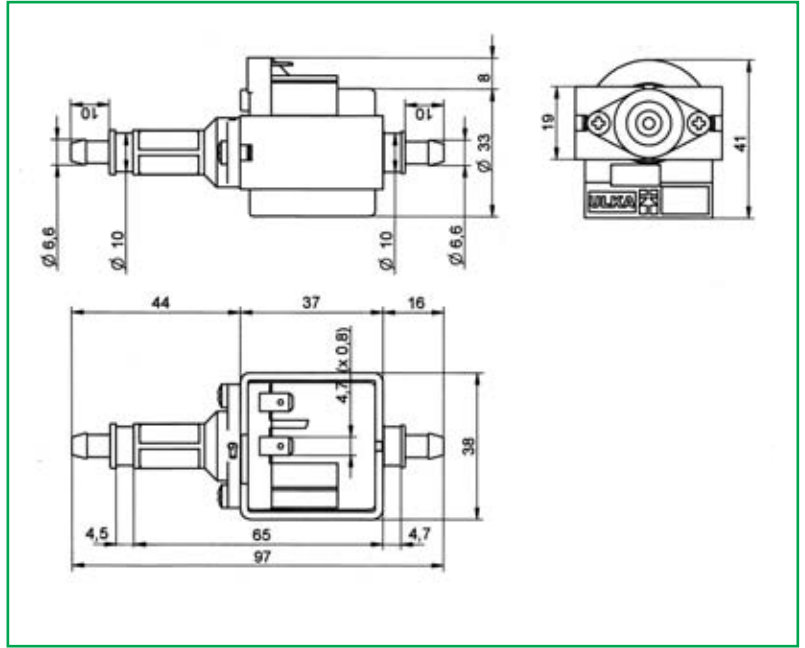

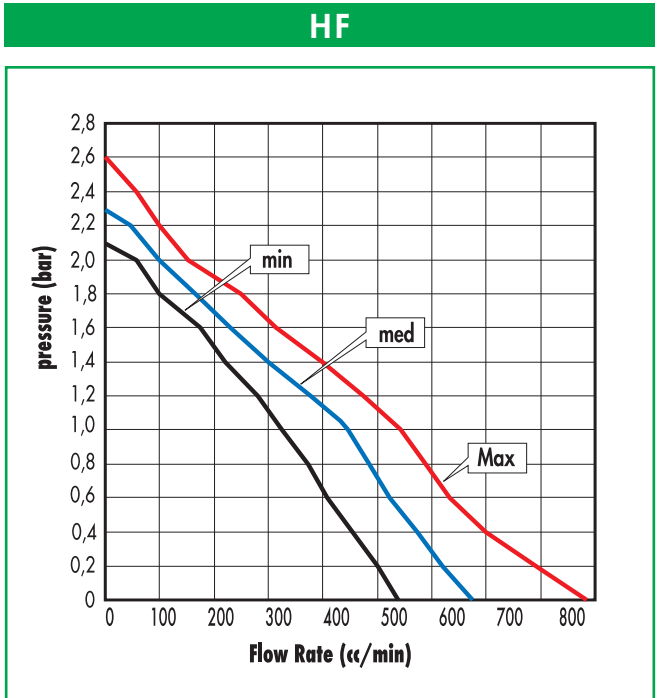

HF					
Models	Voltage	ON/OFF (min)	Class	W	Certificates
HF	230V~50Hz	2/1	F	22	VDE
	120V~60Hz	2/1	F	23	c-UI
	100V~50-60Hz	2/1	F	22	-
	220V~60Hz	2/1	F	22	-

- Double Insulation
- Self-priming without counterpressure
- Suitable to dry-use only during priming
- "ND"=Without integrated Diode in case the pumps is supplied by an electronic management
- $\Delta T=110^{\circ}\text{C}$ Max at $V=V_n+6\%$ - 2 min ON/1 min OFF - $p=0$ bar

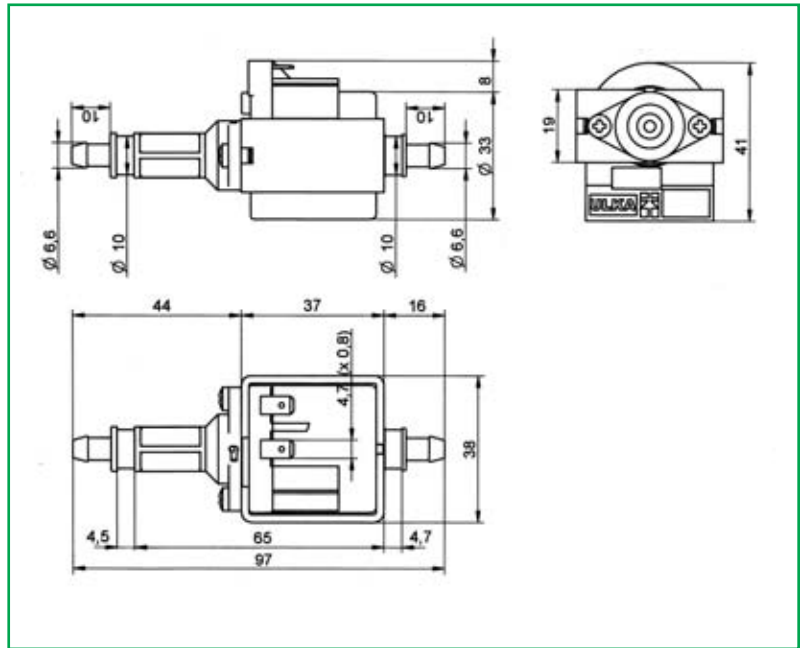









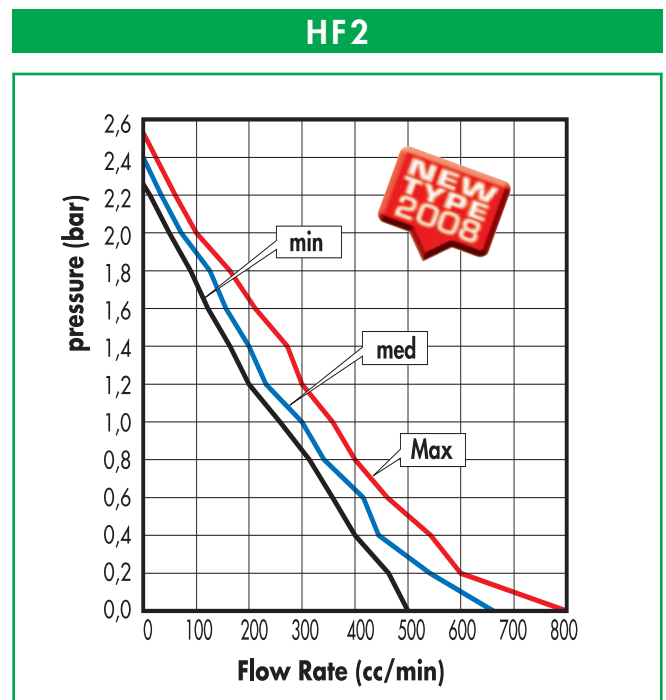

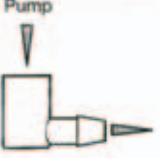

HF2					
Models	Voltage	ON/OFF (min)	Class	W	Certificates
 HF2	230V~50Hz	100%	F	18	-
	120V~60Hz	100%	F	18	-

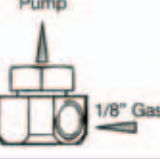
Temporary - Values to be set up

- Double Insulation
- Self-priming without counterpressure
- Suitable to dry-use only during priming
- "ND"=Without integrated Diode in case the pumps is supplied by an electronic management
- $\Delta T=110^{\circ}\text{C}$ Max at $V=V_n+6\%$ - ED 100% - $p=0$ bar



FITTING E MODELS

	ACCESSORI	FITTINGS
	Lato Aspirazione Pompa	Suction head
 	Aspirazione a pressione atmosferica: Pipetta in Santoprene	Atmospheric pressure suction: Pipetta in Santoprene
 	Aspirazione mediante allacciamento alla rete idrica: Raccordo Bar in ottone	Suction through water pipe network connection: Raccordo Bar in brass
	Lato Mandata Pompa	Delivery head
	Raccordo 90° Connessione a 90°	Raccordo 90° Connecting device
 	Valvola "S2": Autoinnesco in contropressione Valvola "S22": Autoinnesco in contropressione e ripristino pressione atmosferica in caldaia	Valve "S2": Self-priming in counter pressure conditions Valve "S22": Self-priming in counter pressure conditions and restoration of the atmospheric pressure in the boiler
 	Valvola "S3": Autoinnesco in contropressione, ripristino pressione atmosferica in caldaia e valvola di sicurezza integrata	Valve "S3": Self-priming valve in counter pressure conditions, restoration of the atmospheric pressure in the boiler and integrated safety valve
 	Valvola "S3BP": Autoinnesco in contropressione, ripristino pressione atmosferica in caldaia e by-pass	Valve "S3BP": Self-priming valve in counter pressure conditions, restoration of the atmospheric pressure in the boiler and by-pass

FITTING NMEHP MODELS

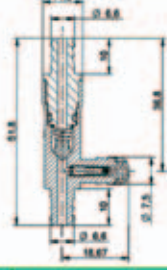
ACCESSORI	FITTINGS
Lato Mandata Pompa	Delivery head
	
Valvola "S4" Autoinnesco in contropressione	Valve "S4" Self-priming in counter pressure conditions





FITTING NME MODELS

ACCESSORI	FITTINGS
Lato Aspirazione Pompa	Suction head
	
Pipetta NME	

FITTING HF MODELS



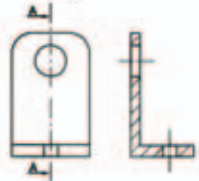

ACCESSORI	FITTINGS
Lato Aspirazione Pompa	Suction head
	
PIPETTA	

FITTING E MODELS

<p>Standard Rubber Mounting 8.01.017</p>  	<p>Square Rubber Mounting 8.01.022</p>  	<p>"ST" Square Rubber Mounting 8.01.039</p>  
--	--	--

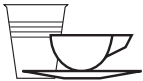
FITTING HF MODELS

<p>Square Rubber Mounting</p> 

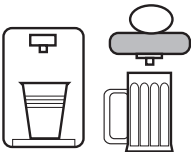
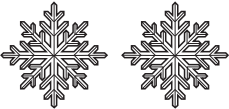
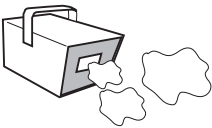
Esempi di APPLICAZIONI TIPICHE		APPLIANCES
	Macchine da Caffè	Coffee Machines
	Lavamoquette Sistemi di Pulizia a Vapore	Carpet Cleaners Steam Cleaning Systems
	Ferri da Stiro / Sistemi Stiranti Presse per Stiratura	Steam Irons / Steam Stations Ironing Presses
	Apparecchi Medicali Apparecchi Odontoiatrici	Medical Equipment Dental Equipment
	Gasificatori d'Acqua Distributori di Bevande	Water Gasifying Equipment Vending Multi-Beverage
	Condizionatori d'Aria	Air Conditioners
	Macchine per Fumo Scenico	Disco Smoke Machines

EVOLUTION PUMP

- Doppio isolamento
 - Alimentazione a corrente alternata come da dati di targa
 - Fluido ideale: acqua alla temperatura di 25°C
 - Funzionamento e potenza assorbita secondo dati di targa
 - Autoinnescante purchè priva di contropressione alla mandata; prevalenza 3mt
 - Non idonea all'utilizzo a secco tranne che per i normali interventi di innesco
 - La bobina è dotata di un marsupio per ospitare un eventuale termoprotettore
 - I componenti sono sottoposti a severi controlli di qualità
- La produzione e il collaudo sono effettuati da un impianto automatizzato e computerizzato che ne garantisce e certifica la qualità nonchè la indispensabile tempestività d'evasione degli ordini.
 - Le prove al 100% comprendono:
 - 1) Prova di rigidità dielettrica verso massa a 2500V per 2 secondi
 - 2) Prova di idraulica, di innesco, di portata, di pressione

- Double insulation
 - AC supply as per label data
 - Ideal fluid: water at 25°C (maximum temperature)
 - Working time and absorbed power as per label data
 - Self-priming without counterpressure at delivery head; 3 mt height
 - Suitable to dry-use only during priming
 - The coil is equipped with a pocket for the possible fitting of a thermal cutout
 - The components are subjected to strict quality controls
- Both production and test are carried out by an automated and computerised system assuring and certifying not only its quality but also the indispensable promptness in executing orders.
 - The full detailed inspection includes:
 - 1) Dielectric strenght test towards mass at 2500V per 2 seconds
 - 2) Hydraulic, Self-priming, Flow-rate and Pressure Tests

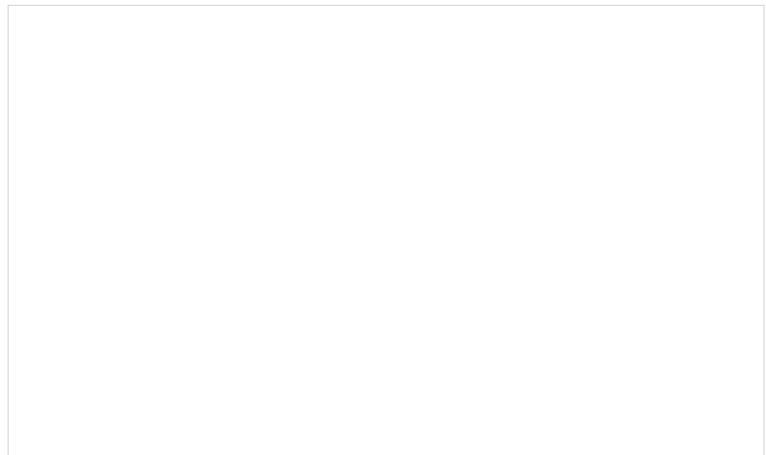



ULKA

COFFEE DIVISION

CEME Spa

Registered Office CEME Spa
Via Camperio, 9 - 20123 Milano - ITALY

Headquarters and Production Site:
Via dell'Artigianato, 6 - 27050 RETORBIDO - PV - ITALY
Tel. +39 03833724.1 - Fax +39 0383 74149
e-mail: coffee@cemegroup.com - www.ulka.it

