



GIAS

Assistenza Tecnica



LAVABIANCHERIA ACCOSTO

31004490 DYT 8126/L-S

Manuale di Servizio

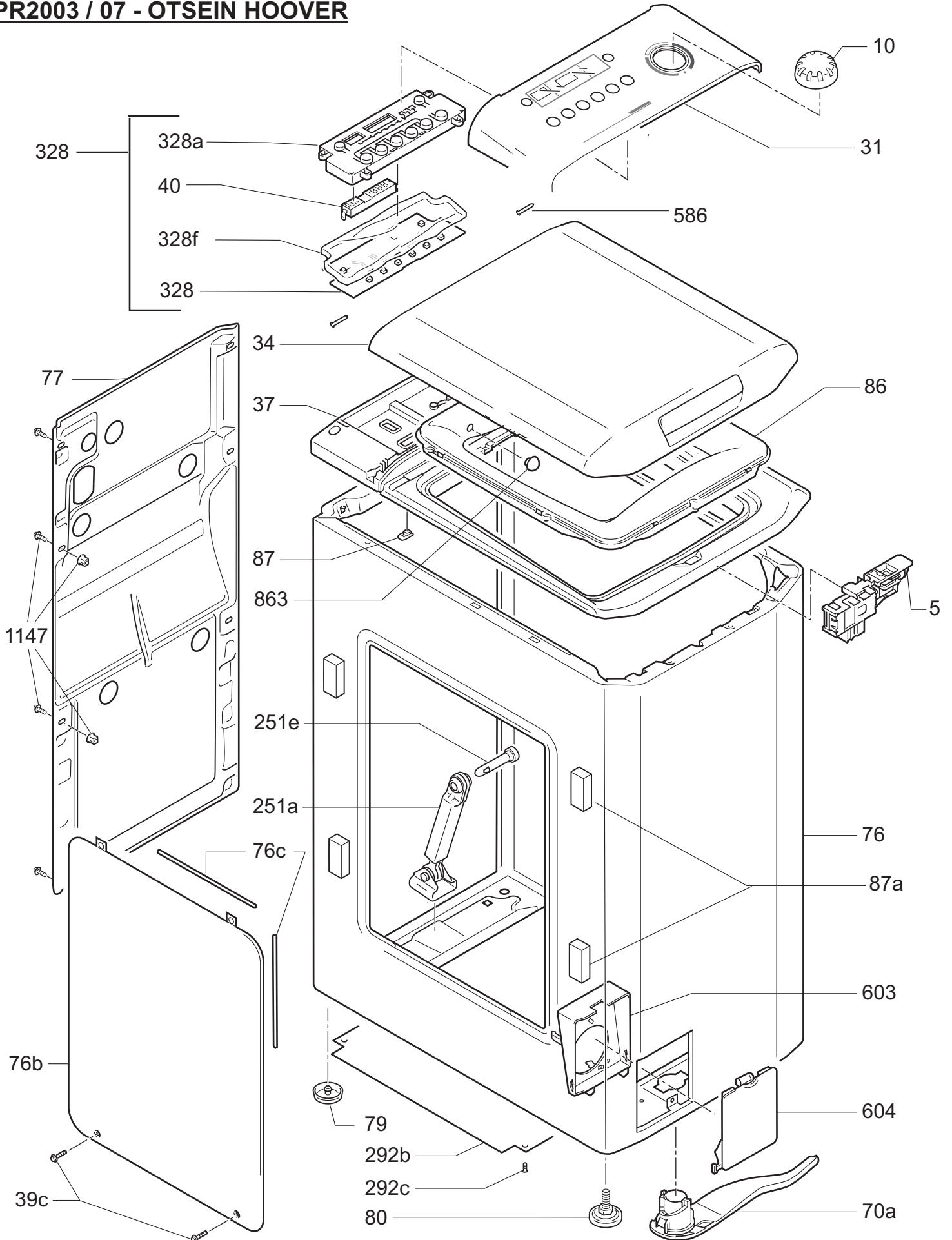

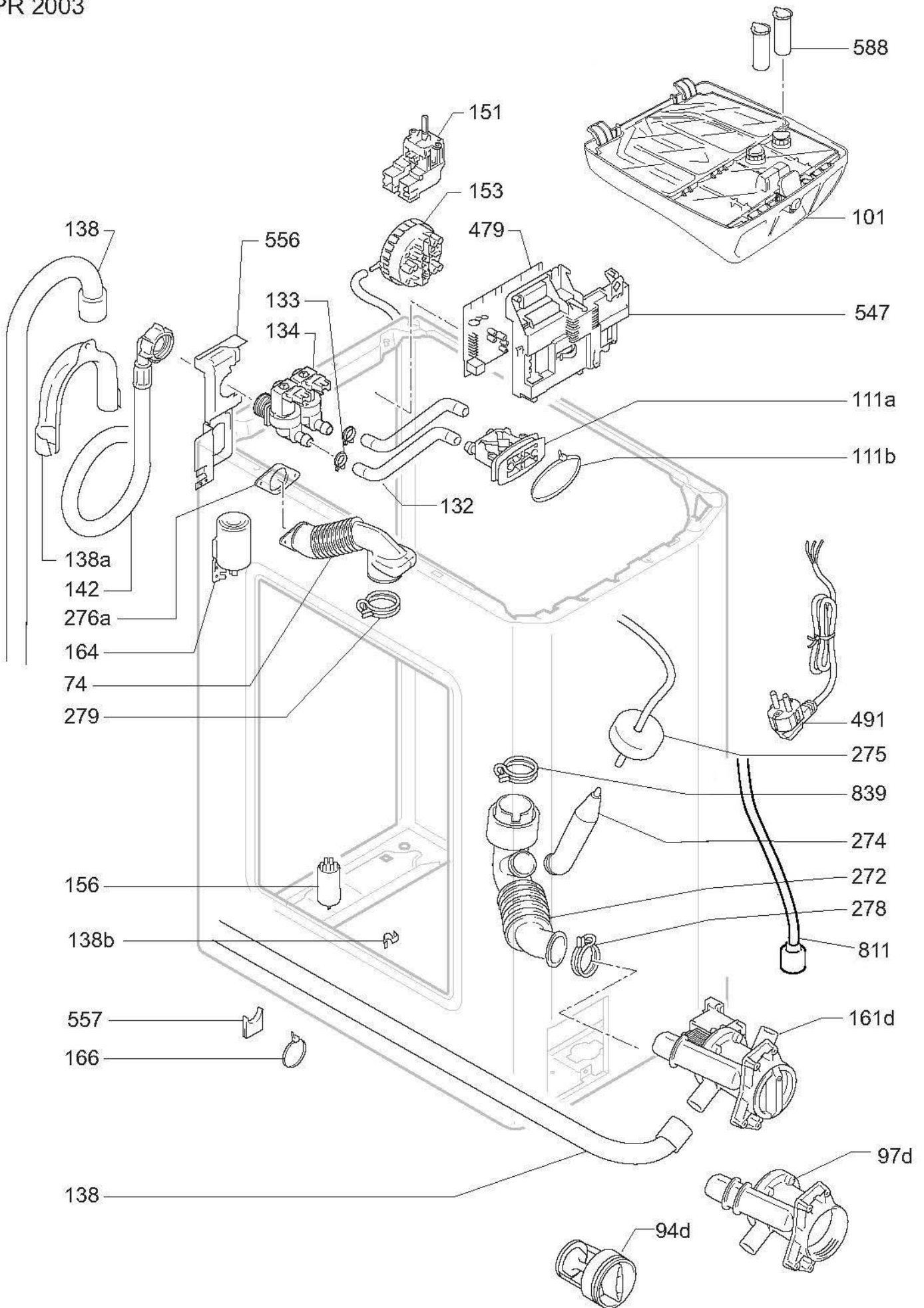

Dibujo despiece cuba y motor

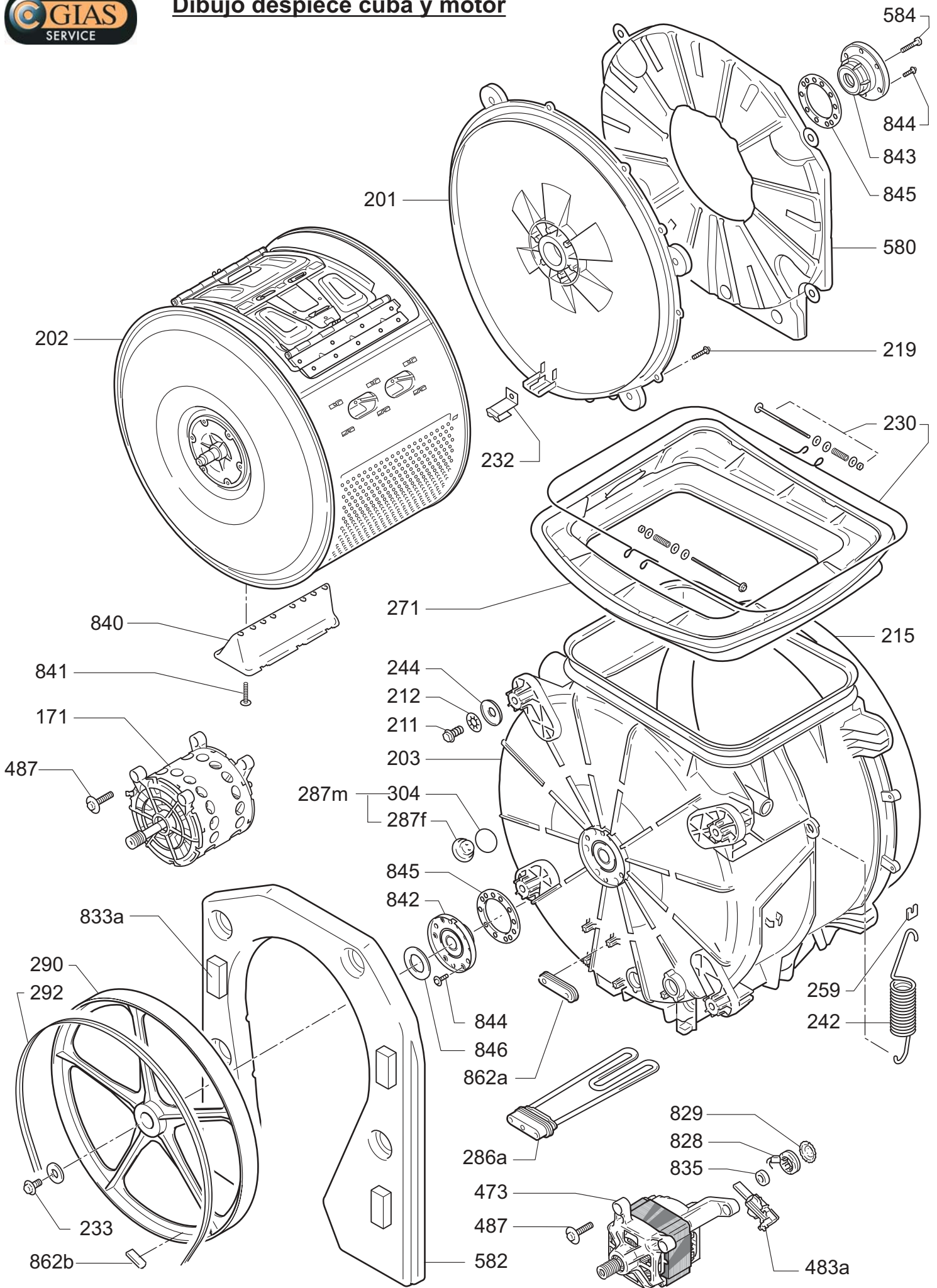



GIAS

Assistenza Tecnica

31004490 DYT 8126/L-S 9953(31/12/2099)



Rif	Descrizione	Codice	Inizio	Fine
5	Bloccaporta	46002826		
10	Manopola timer/selettore	46005473		
14h	Molla manop.termos/potenz	46000509		
25	Mascherina cruscotto	46005376		
26	Mascherina tasti	46005377		
31	Cruscotto	46005778		
34	Coperchio	46005360		
37	Passamano	46004798		
39c	vite autofilettante	80007321		
70a	Ass.telaio con ruote	46001521		
74	Tubo scarico vapore	46004813		
76	Mobile	46004778		
76b	Coperchio lat.mobile	80049583		
76c	Guarn.lat.coperch.mobile	80007172		
77	Pannello posteriore	46004781		
79	Piedino posteriore	92606474		
80	Piedino anteriore	41011335		
86	Cornice superiore	46004790		
101	Bacinella carico sapone	46005155		
111a	Assieme spruzzatore	46002848		
132	Tubeetto carico	46002053		
133	Cravattino	92470012		
134	Elettrovalvola	41032538		
138	Tubo scarico	92693373		
138a	Curva tubo scarico	80001787		
142b	Tubo di carico con sicurezza rosso	92968155		
151h	Selettore 12 posizioni	41033178		
153	Pressostato	41026305		
157	Cablaggio	46004934		
157x	Flat cable	46003144		
158	Basetta linea	91623678		
161	Pompa scarico/ricircolo	46005410		
164	Filtro antidisturbo	91200098		
201	Flangia anteriore	46006084		
202	Cestello	46005372		1225(18/06/2012)
202	Cestello	46007014	1225(18/06/2012)	
203	Vasca	46006327		
206a	Kit tapparelle	81453393		
206b	Kit copertura tapparelle	81453392		
211	Tirante	46004844		
211a	Tirante destro	46001345		
215	Guarnizione vasca	46004812		
219	Vite	46000590		
230	Anello tenuta giunto	46000125		
233a	Vite fiss.puleggia	46001626		
238	Vite	46004927		
242	Mollone portante	46004806		
244	Rondella	80000664		
251a	Ammortizzatore telescopico	46004817		1209(01/03/2012)
251a	Ammortizzatore telescopico	46006233	1209(01/03/2012)	























GIAS











Assistenza Tecnica







Rif	Descrizione	Codice	Inizio	Fine
251e	Perno ammortizzatore	41017173		
259	Supportino	46004011		
271	Giunto elastico	46001221		
272	Pipa scarico	46002537		
274	Raccordo pipa pressostato	91611202		
275	Tubo vipla 5x8	80024987		
276a	Griglia soffiato vapore	80049867		
286a	Resistenza+NTC	41034901		
287m	Sonda NTC	49015420		
290	Puleggia cesto	46004459		1225(18/06/2012)
290	Puleggia cesto	46006145	1225(18/06/2012)	
292a	Cinghia estensibile	80001704		
292b	Pannello di fondo	46005061		
328	Scheda elettr. cruscotto	41031978		
328a	Contenitore scheda elettr. cruscotto	46005390		
473	Motore a collettore	46000184		
479t	Scheda cuore INVENSYS non programmata	46004871		
479u	Scheda cuore INVENSYS programmata	81453563		
483a	Spazzola con portaspaz.	81451998		
487	Bullone speciale	46000559		
491	Cavo linea	91200194		
546	Inserito masch.cruscotto	46005498		
547	Custodia modulo	46004872		
556	Supporto elettrovalvola	46004890		
557	Gancio supp.tubo	80001753		
580	Contrappeso anteriore	46004733		
582	Contrapp.lato puleggia	46004734		
586	Perno controcooperchio	80049343		
588	Sifone	46003427		
603	Protezione autopulente	46003744		
604	Portellino filtro	46003745		
811	Tubi ricircolo	46004789		
828b	Bobina tachimetrica	49000464		
832	Fascetta pipa scarico	91408004		
834	Appoggio contrap.inferior	92898923		
835a	Magnete	49000465		
840a	Pala cesto contrappesata	46005147		
841	Vite pala cesto	80040231		
842	Disco cuscinetto vasca	46005903		
845	Guarnizione	46000255		
848	Spina	46004143		
862a	Reed dispositivo freno cesto	46004983		
862b	Calamita dispositivo freno cesto	46004413		
863	Fermoporta di gomma	46000692		
1147	Kit staffaggio	81453230		
1147a	Kit fissaggio pannello posteriore	81452281		

 **40 °C**



 **8:35**



 **12:00**











1200 rpm   **Aqua Stop**
 DYT 8126













DYNAMIC TOP
8+

STOP*
 LOAD EASY
 LOAD



HOOVER

ECO  TECHNOLOGY